

Overview

Low-profile ceiling speakers designed for superior music reproduction



Features

- Series offers different woofer sizes in either black or white.
- Engineered for optimum BGM reproduction.
- Wide coverage allows a single speaker to cover a wide area.
- Designed with optimized bass-reflex tuning to offer a firm, tight low-end.
- Low-profile design facilitates installation in limited ceiling spaces.
- Equipped with internal transformers that allow both high and low impedance drive, which can be selected by simply switching the tap on the baffle.
- Anti-drop tab mechanism provide secure temporary positioning during installation.
- A flexible carrying band makes the speakers very portable and allows carrying multiple speakers at once.
- Comes complete with O-rings and tile rails for safer and smoother installation.
- Overload protection circuit provided to protect speaker components.
- Comes with paintable speaker grilles for flexible design ideas.

Specifications

General Specifications

System Type	Full-range, Bass-reflex	
Components	3.5" full-range	
Frequency Range	(-10dB)	71Hz-20kHz*1
Coverage Angle (Horizontal x Vertical)	140° conical*1	
Nominal Impedance	8Ω	
Transformer Taps	70V	15W, 7.5W, 3.8W, 1.9W
	100V	15W, 7.5W, 3.8W
Power Rating	NOISE	20W
	PGM	40W
	MAX	80W
Sensitivity (1W, 1m)	87dB SPL ¹	
Maximum SPL (Calculated, 1m)	106dB SPL ²	
Connectors	1 x Euroblock (4 pin) (input: +/-, loop-thru: +/-)	
Material, Finish, Color	Black, White	
Dimensions (W x H x D)	Ø285mm x 112mm (11.2" x 4.4")	
Net Weight	2.5kg (9.8lbs)	
Packaging	Pair	
Cutout Size	Ø247mm (Ø9.8")	
Certificate	UL1480, NFPA70, CE, EAC, RoHS	

*1 Half space (2π)

*2 Calculated based on power rating and sensitivity, exclusive of power compression

Accessories

Included Accessories	O-ring, Tile Rail, Cutout Template, Euro Block (4pin), Terminal Cover
----------------------	---

Dimensions

Unit: mm (inch)

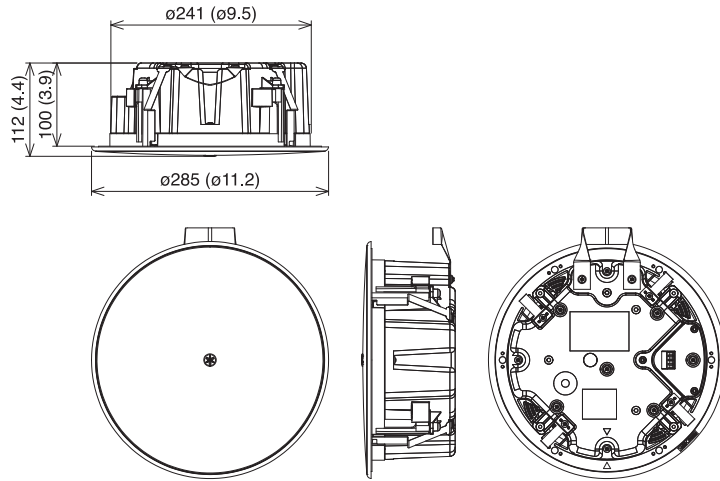

O-ring

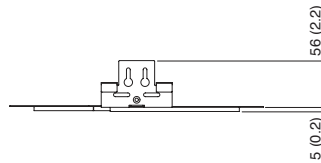
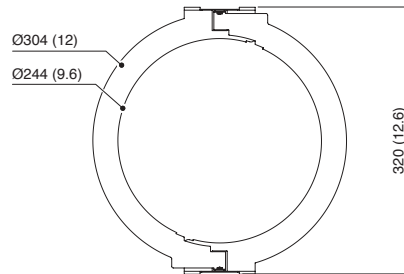

Tile Rail

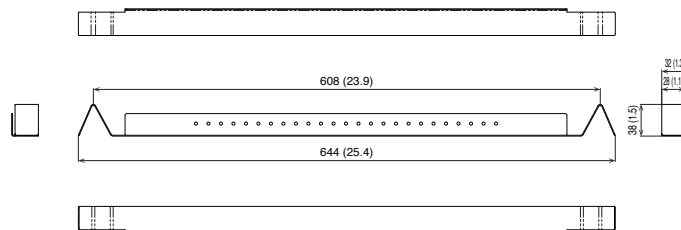

Architectural and Engineering Specifications

The loudspeaker shall be of in-ceiling design, a full-range bass-reflex type and shall have a back can. The loudspeaker shall consist of a 3.5" (9cm) cone driver. The loudspeaker shall be equipped with internal transformers that allow both high-impedance and low-impedance drive. The Anti-Drop tab shall be provided for improved safety and ease of installation that allows the loudspeaker to be mounted temporarily in the ceiling. The flexible carrying band shall be provided for improved portability. The power rating shall be set by switching a transformer tap on the baffle as follows: 15W/7.5W/3.8W in 100V line; 15W/7.5W/3.8W/1.9W in 70V line; and 40W into 8 ohms. The loudspeaker shall be capable of meeting the following performance criteria: The measured sensitivity shall be 89dB SPL (at 1W, 1m, in half-space); The maximum SPL shall be 111dB SPL (at 1m); The frequency range shall be 60Hz-20kHz (10dB below rated sensitivity, in half-space); The nominal coverage angle shall be 140° polar conical. The loudspeaker shall be provided for an overload protection circuit to protect network and transducers. The 4-pin Euroblock connector shall be provided for an input and a loop-thru. The grille shall have the following color variation: black-painted (VXC3F) or white-painted (VXC3FW). Overall front face diameter of the loudspeaker shall not exceed 285mm (11.3"), overall depth from the bottom of the ceiling shall not exceed 112mm (4.4"), and shall weigh no more than 2.5kg (5.5lbs). The loudspeaker shall have included accessories as follows: The O-rings and the tile rails shall be included for safer and smoother installation. The loudspeaker shall be equipped with an eyelet for secondary safety wire usage. The loudspeaker shall be the Yamaha VXC3F or VXC3FW.

Sensitivity

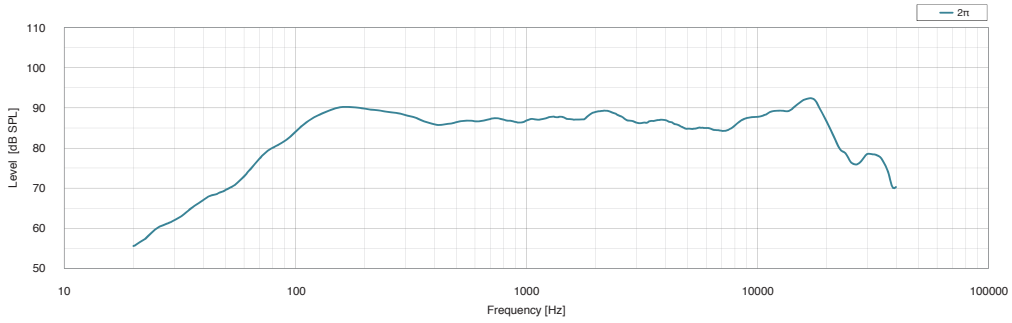

Beamwidth

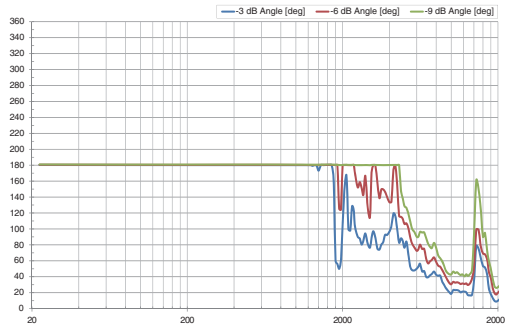

Directivity Index

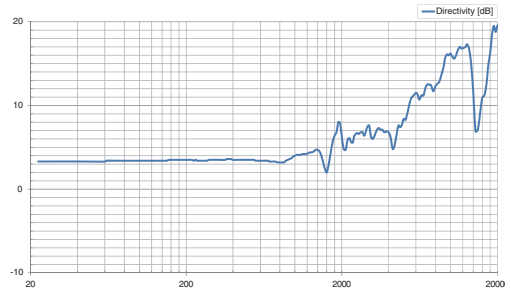

Polar Plots

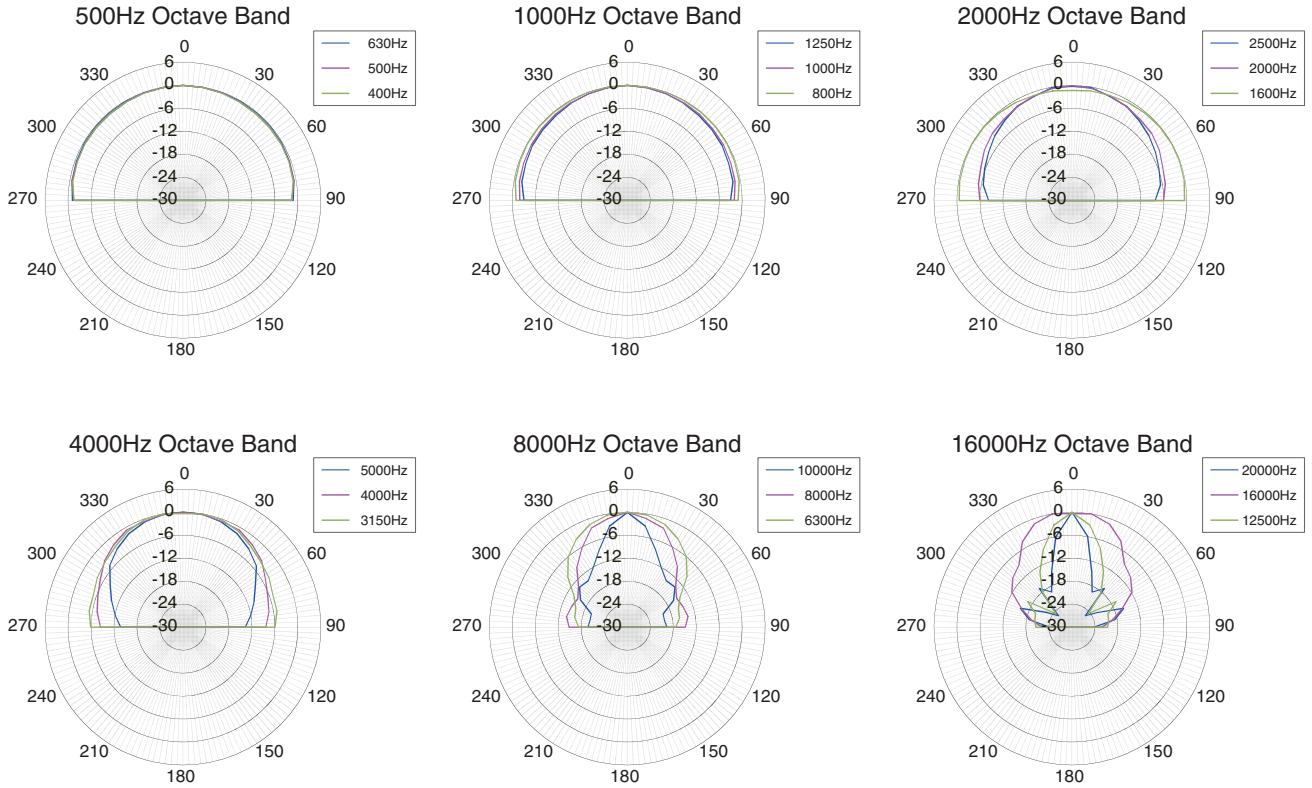

*All information subject to change without notice.

*All trademarks and registered trademarks are property of their respective owners.

Created in March, 2017